

GAMME INOX

Poteaux | Acier Inoxydable

Des poteaux polyvalents pour protéger les angles de mur, portes et autres éléments sensibles

- Montage au sol avec collerette masquant le système de fixation.
- Acier inoxydable brossé.
- 900 x 100 mm

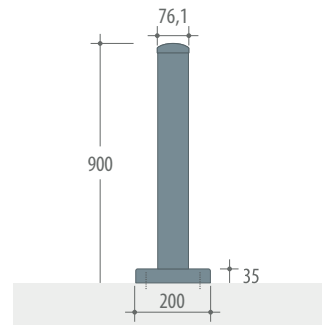
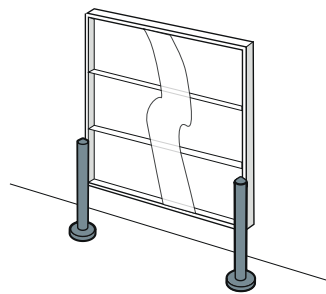
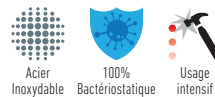

Protection d'angles | Acier Inoxydable

Un pare-chocs extrêmement robuste pour protéger les angles de murs contre les assauts des charges roulantes

- Pare-chocs tubulaire et fixations en inox.
- Acier inoxydable brossé.

- Design assorti au BIO LIGN TUBE.
- 275 x 275 x 50 mm

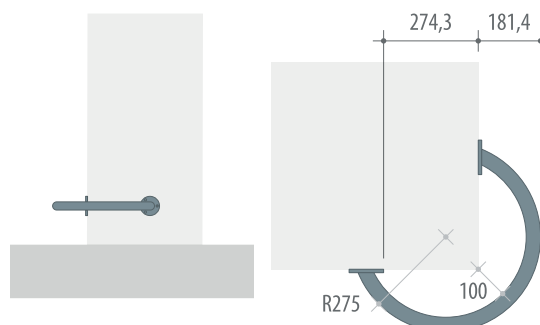
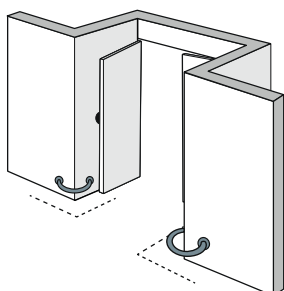
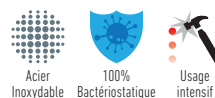

GAMME INOX

BIO LIGN 100/150/200 | Acier Inoxydable

**Pare-chocs en inox pour usage intensif.
A utiliser dans des locaux où l'hygiène est importante**

- Kit sur mesure prêt à poser, avec réglette de fixation pré-percée.
- Épaisseur du matériau : 1,2 mm
- Acier inoxydable brossé, qualité alimentaire (304 L)
- 3 000 x 200 x 32 mm
- 3 000 x 150 x 32 mm
- 3 000 x 100 x 32 mm
- Extrémités fermées soudées

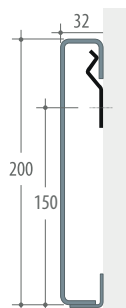
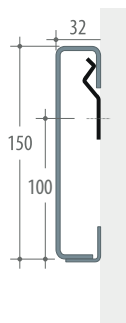
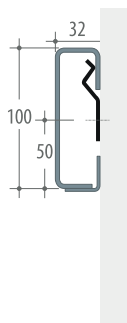

BIO LIGN TUBE | Acier Inoxydable

Pare-chocs tubulaire, adapté pour protéger des grandes surfaces vitrées, des meubles ou des murs

- Pare-chocs tubulaire en acier inoxydable avec fixations par consoles en inox
- Acier inoxydable brossé
- 3 000 x 51 x 51 mm
- Embout standard
- Embout externe
- Embout interne
- Embout bouchon
- Eclisse
- Système de fixation par consoles en inox

